

uitwerkbijlage

Naam kandidaat _____ Kandidaatnummer _____

4

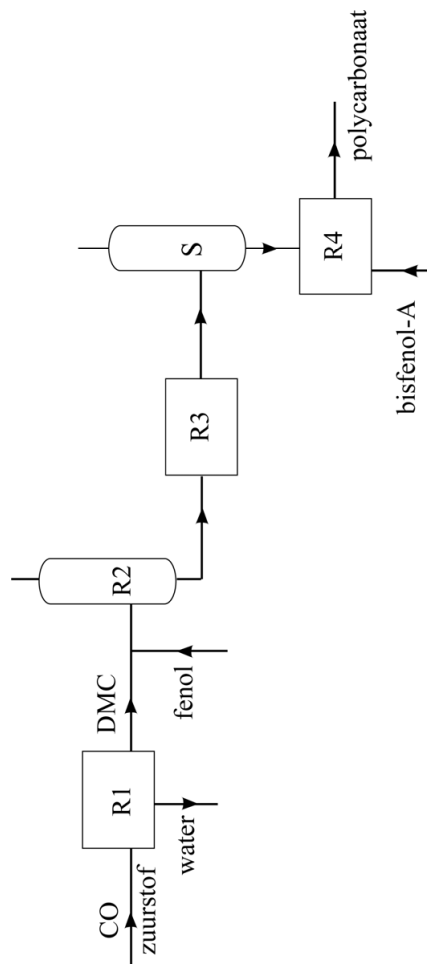

20

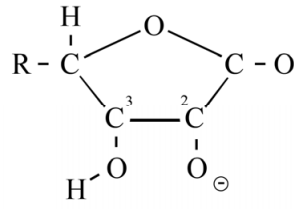
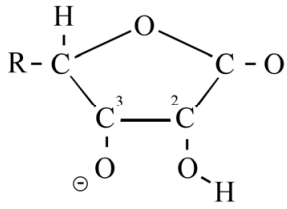

21

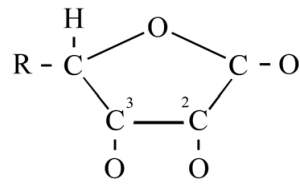

VERGEET NIET DEZE UITWERKBIJLAGE IN TE LEVEREN