

uitwerkbijlage

Naam kandidaat _____ Kandidaatnummer _____

3

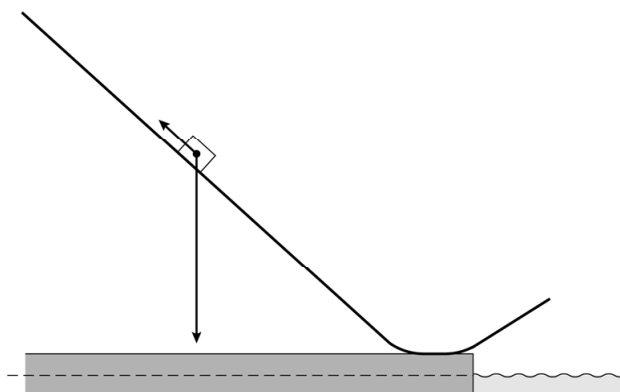

8

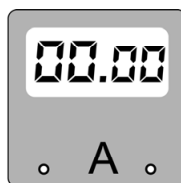

VERGEET NIET DEZE UITWERKBIJLAGE IN TE LEVEREN